

78 mm

3 PC DIGITAL TORQUE ADAPTER

Stock Number M206

OWNER'S MANUAL



FOR YOUR SAFETY, please read these instructions carefully and retain them for future use.



LIMITED WARRANTY CONT.

Except for warranties of title and the limited express warranties set forth above, PERFORMANCE TOOL® makes no express or implied warranties of any kind with respect to its products. In particular, PERFORMANCE TOOL® makes no implied warranty of merchantability and no implied warranty of fitness for any particular purpose, except that for goods purchased primarily for personal, family or household use and not for commercial or business use, PERFORMANCE TOOL® makes an implied warranty of merchantability (and, if otherwise applicable, an implied warranty of fitness for a particular purpose), but only for the particular qualities or characteristics, and for the duration, expressly warranted above.

The laws on limitation of implied warranties may differ from state to state, so the above limitations may not apply in all cases.

PERFORMANCE TOOL® shall not be liable for consequential, incidental or special damages resulting from or in any manner related to any product, or to the design, use, or any inability to use the product. The sole and exclusive remedy for a defective product or part shall be the repair, or replacement thereof as provided above. The laws on limitation of remedies or on consequential, incidental or special damages may vary from state to state, so the above limitations may not apply in all cases.

© Copyright 2014 WILMAR CORPORATION, P.O. Box 88259 Tukwila, WA 98138

COVER

BACK

FEATURES

- 1/2 in. Drive.
- Clockwise and counter-clockwise operation.
- Readout adapter is rotatable for ease of use
- Buzzer and LED torque indication.
- +/-2% accuracy.
- Measuring units: kg-cm, kg-m, ft-lb, in-lb, N-m.
- Automatic sleep mode after 3 minutes of non- activity.

WARNING!
READ, UNDERSTAND AND FOLLOW ALL INSTRUCTIONS AND WARNINGS BEFORE OPERATING THIS TOOL. FAILURE TO DO SO MAY RESULT IN PERSONAL INJURY AND/OR PROPERTY DAMAGE AND WILL VOID WARRANTY.

1.

SPECIFICATIONS

Model #:	M206
Accuracy:	+/-2%
Torque Range:	30 -150 ft/lb(40 ~ 200 Nm)
Resolution:	0.1 Nm
Pre-Settings:	10 Sets
LED Type:	Red
Unit:	kg/cm, kg/m, ft/lb, in/lb, N/m
Ratchet Size:	1/2 in.
Battery Type:	DC 3V, CR2032
Operating Temp:	-10°C ~ 60°C
Storage Temp:	-20°C ~ 70°C

2.

SAFETY INFORMATION

1. Keep work area clean.
2. Keep children away. Children must never be allowed in the work area. Do not let them handle machines, tools, hoses or extension cords.
3. Store idle equipment. When not in use, tools must be stored in a dry location to inhibit rust.
4. Always wear approved eye protection when using tools. If raising dust, wear a suitable mask.
5. Work Safe. Do not wear loose clothing or jewelry that could become caught by moving parts, causing injury. Operate tool a safe distance from yourself and others in the work area. Keep proper footing and balance at all times. Do not reach over or across running machines, hoses, etc.
6. Do not operate any tool if under the influence of alcohol or drugs. Read warning labels on prescriptions to determine if your judgment or reflexes are impaired while taking drugs. If there is any doubt, do not operate any tool.
7. Use only those accessories that are designed for use with tools. For example, with impact wrenches do not use ordinary sockets. Use impact sockets for all air tools.
8. Check for damaged parts. Before using any tool,

3.

SAFETY INFORMATION CONT.

any part that appears damaged should be carefully checked to determine that it will operate properly and perform its intended function. Check for alignment and binding of moving parts; any broken parts or mounting fixtures; and any other condition that may affect proper operation. Any part that is damaged should be properly repaired or replaced by a qualified technician.

WARNING: This product and its packaging contain a chemical known to the State of California to cause cancer, birth defects, or other reproductive harm.

WARNING: The warnings, cautions, and instructions discussed in this instruction manual cannot cover all possible conditions and situations that may occur. It must be understood by the operator that common sense and caution are factors which cannot be built into this product, but must be supplied by the operator. Read and understand all of the instructions provided in the instruction manual of this product, as well as, any other tool(s) used with this product.

4.

CONTROLS & FUNCTIONS

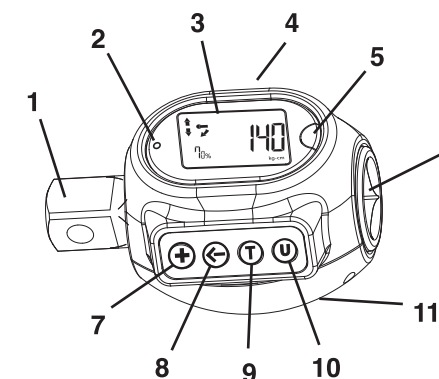

- 1 - Adapter
- 2 - LED Indicator
- 3 - LCD display
- 4 - Buzzer(side)
- 5 - MODE Button
- 6 - Adapter
- 7 - ⊕ Add Value
- 8 - ⊖ Digit Shift
- 9 - ⊕ Peakhold/Track
- 10 - ⊖ Unit
- 11 - Battery Lid

5.

DISPLAY INDICATORS

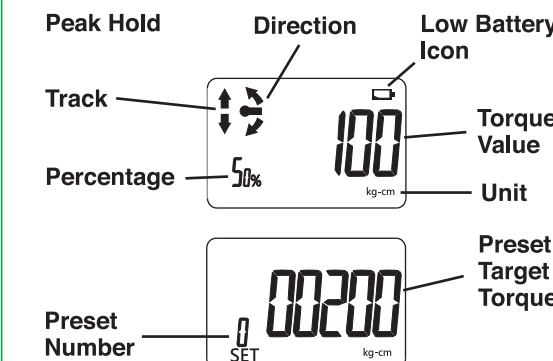

OPERATION

- Press the Mode button to turn on the digital torque adapter and an auto-zeroing process will be done.
- Make sure the torque is zero when in the process of auto-zeroing. If force is applied the offset will be included in the reading.

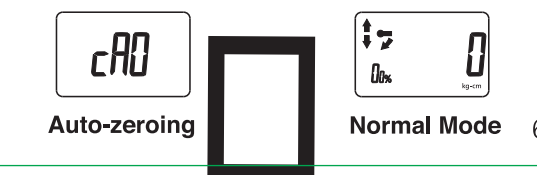

6.

TRACK MODE OPERATION

In Normal Mode (Track Mode) select pre-setting of 200kg-cm.



With 50% of the Target Torque.

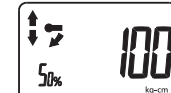

With 70% of the Target Torque.

Buzzer sound: (Bi---Bi---Bi---)

Red Light: (○●●●●●●●)

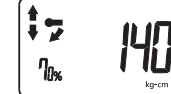

With 90% of the Target Torque.

Buzzer sound: (Bi--Bi--Bi--)

Red Light: (●○●○●○●○)



When Target Torque is reached.

Buzzer sound: (BiBiBiBiBiBi)

Red Light: (●●●●●●●●)



ATTENTION: If the value of the selected presetting is zero. A default value equal to 120% of the maximum torque for this adapter will be loaded as the Target Torque.

7.

PEAK HOLD MODE OPERATION

In Normal Mode (Peak Hold) select pre-setting of 200kg-cm.



With 50% of the Target Torque.

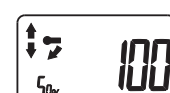

Apply Torque.

Buzzer sound: (BiBiBiBiBiBi)

Red Light: (●●●●●●●●)

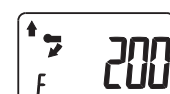

Release torque to zero.

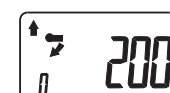

Repeat steps.



ATTENTION: If the adjusted value of the pre-setting is more than 120% of the maximum torque for this adapter, the value will be reset to zero.

8.

SETTING

- 1 - Power ON/OFF Backlight
- 2 - Add Value
- 3 - Digit Shift Left
- 4 - Confirm/Peal/Track
- 5 - Unit

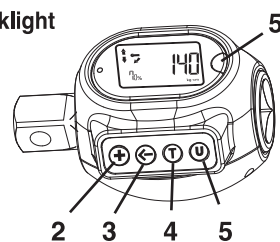

Select 1 of 10 pre-settings:

Press ⊕ = Pre-setting No. 0



Press ⊕ = Pre-setting No. 1



Press ⊖ =



9.

Adjust pre-setting value:

Press ⊖

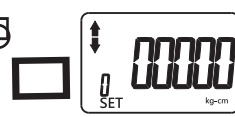

Press ⊕

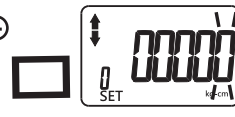

Press ⊖

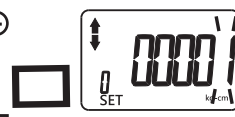

Press ⊕

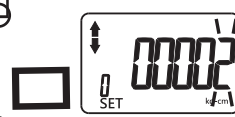

Press ⊖

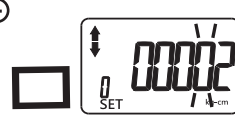

Press ⊕

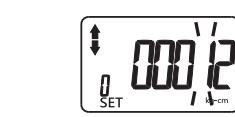

10.

Peak Hold/Track Mode selection:

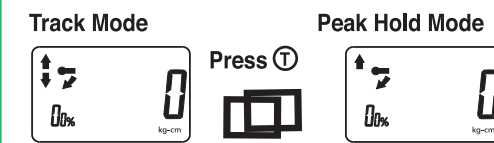

CHANGING DISPLAY DIRECTION

Press and hold ⊕ button for 2 seconds to toggle the direction of the display.



TURNING OFF ADAPTER

Press and hold Mode button for 2 seconds to turn off the adapter.

When no activity has been detected for 3 minutes, this unit will automatically enter sleep mode to save battery power.

11.

LOW BATTERY INDICATOR

When battery voltage is under 2.6V a low battery icon will be shown on the display.



When battery voltage is under 2.4V a low battery icon will be blinking on the display. Battery replacement is necessary.

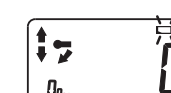

BATTERY REPLACEMENT

1. Use a precision Phillips head screwdriver to open the battery compartment.

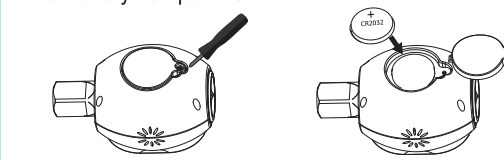

2. Replace the CR2032 battery.

ATTENTION: Insert the battery with the "+" charge facing upward.

12.

ADJUSTABLE VIEW

Rotatable mechanism allows 240° rotation for easily viewing information shown on the LCD display.

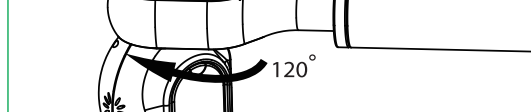
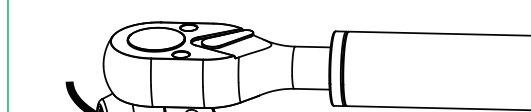

13.

LIMITED WARRANTY

PERFORMANCE TOOL® extends only the following warranties, and only to original retail purchasers. These warranties give specific legal rights. Except where prohibited by local law, the law of the State of Washington governs all warranties and all exclusions and limitations of warranties and remedies. There may be other rights which vary from state to state.

PERFORMANCE TOOL® warrants the product to be free from defects in materials and workmanship under normal use and service. A defective product may be returned for a free replacement within 90 days from the date of purchase, provided that product is returned to place of purchase immediately after discovery of defect. After 90 days and up to one year from date of purchase, PERFORMANCE TOOL® will replace at no charge any parts which our examination shall disclose to be defective and under warranty. These warranties shall be valid only when a sales receipt showing the date of purchase accompanies the defective product or defective part(s) being returned. For part(s) after 90 days, please remit your request, postage prepaid to: PERFORMANCE TOOL, P.O. Box 88259 Tukwila, WA 98138

These warranties exclude blades, bits, punches, dies, bulbs, fuses, hoses, and other consumables which must be replaced under normal use and service. These warranties shall not apply to any product or part which is used for a purpose for which it is not designed, or which has been repaired or altered in any way so as to affect adversely its performance or reliability, nor shall these warranties apply to any product or part which has been subject to misuse, neglect, accident or wear and tear incident to normal use and service. PERFORMANCE TOOL® does not authorize any other person to make any warranty or to assume any liability in connection with its products.

14.

7

8

9

10

11

12

13

14